

# Network Video Recorder

## NVR301-S3-P Series



### Key Features

- Support Ultra265/H.265/H.264 video formats
- 4/8-channel input
- Plug & Play with 4/8 independent PoE network interfaces
- Third-party IP cameras supported with ONVIF conformance: Profile S, Profile G, Profile T
- Support 1-ch HDMI, 1-ch VGA
- Up to 4K resolution recording
- 1 SATA HDDs, up to 6 TB
- Support cloud upgrade

## Specifications

Model	NVR301-04S3-P4	NVR301-08S3-P8
<b>Video/Audio Input</b>		
IP Video Input	4-ch	8-ch
<b>Network</b>		
Incoming Bandwidth	64Mbps	
Outgoing Bandwidth	48Mbps	
Remote Users	128	
Protocols	P2P, UPnP, NTP, DHCP, PPPoE	
<b>Video/Audio Output</b>		
HDMI/VGA Output	HDMI: 3840x2160/30Hz, 1920x1080p/60Hz, 1920x1080p/50Hz, 1600x1200/60Hz, 1280x1024/60Hz, 1280x720/60Hz, 1024x768/60Hz VGA: 1920x1080p/60Hz, 1920x1080p/50Hz, 1600x1200/60Hz, 1280x1024/60Hz, 1280x720/60Hz, 1024x768/60Hz	
Recording Resolution	4K/5MP/4MP/3MP/1080p/960p/720p/D1/2CIF/CIF	
Audio Output	1-ch, RCA	
Synchronous Playback	4-ch	8-ch
Corridor Mode Screen	3/4	3/4/5/7/9
<b>Decoding</b>		
Decoding format	Ultra265/H.265/H.264	
Live view/Playback	4K/5MP/4MP/3MP/1080p/960p/720p/D1/2CIF/CIF	
Capability	1 x 4K@30, 4 x 5MP@25, 4 x 4MP@25, 4 x 3MP@25, 4 x 1080p@30	1 x 4K@30, 4 x 5MP@25, 4 x 4MP@25, 4 x 3MP@25, 4 x 1080p@30, 8 x 720p@30
<b>Hard Disk</b>		
SATA	1 SATA interfaces	
Capacity	Up to 6TB for each disk	
<b>Smart</b>		
VCA Detection	Face detection, Intrusion detection, Cross line detection, Audio detection	
VCA Search	Face search, Behavior search	
<b>External Interface</b>		
Network Interface	1 RJ-45 10M/100Mself-adaptive Ethernet Interface	
USB Interface	Rear panel: 2 x USB2.0	
<b>PoE</b>		
Interface	4 RJ-45 10M/100Mself-adaptive Ethernet Interface	8 RJ-45 10M/100Mself-adaptive Ethernet Interface
Max Power	Max 30W for single port Max 54W in total	Max 30W for single port Max 75W in total
Supported Standard	IEEE 802.3at, IEEE 802.3af	
<b>General</b>		
Power Supply	48V DC Power Consumption: ≤9 W (without HDD)	52V DC Power Consumption: ≤9 W (without HDD)
Working Environment	-10°C~+ 55°C (+14°F~+131°F), Humidity ≤ 90% RH (non-condensing)	
Dimensions (W×D×H)	260mm ×240mm × 46 mm (10.2" × 9.4" ×1.8")	
Weight (without HDD)	≤1.1kg (2.43lb)	

## Dimensions

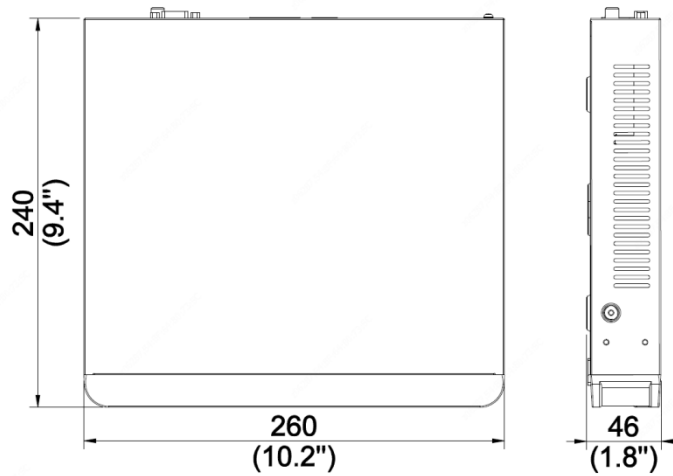

## Rear Panel

Take **NVR301-04S3-P4** for example

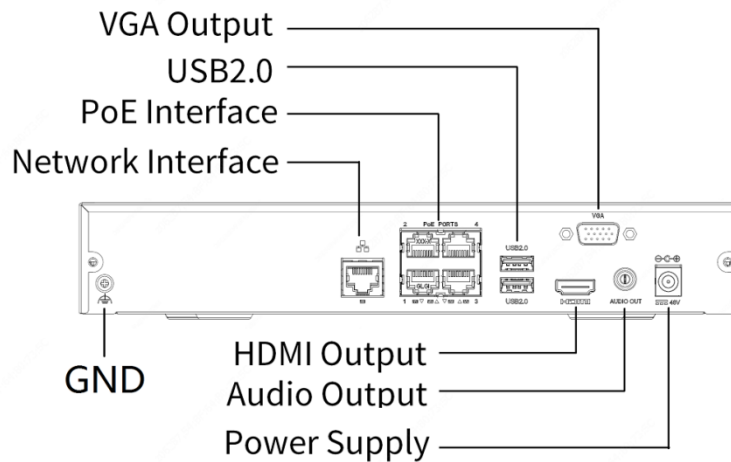

**Zhejiang Uniview Technologies Co., Ltd.**

Building No.10, Wanlun Science Park, Jiangling Road 88, Binjiang District, Hangzhou, Zhejiang, China

Email: [overseasbusiness@uniview.com](mailto:overseasbusiness@uniview.com); [globalsupport@uniview.com](mailto:globalsupport@uniview.com)

<http://sgcdn.uniview.com>

©2020 Zhejiang Uniview Technologies Co., Ltd. All rights reserved.

\* Product specifications and availability are subject to change without notice.