

DS-2DE5425IWG-4G 4 MP 25 × Network IR Speed Dome



- Supports performance mode and low power mode. The consumption is 3 W in low power mode, and 0.3 W in sleep mode
- Built-in heating glass for effective defog
- Water and dust resistant (IP66)
- The built-in eMMC storage is up to 256 GB
- Supports Wi-Fi AP for short-distance debugging; The Wi-Fi module of this product only supports AP mode on Channel 11, and does not support other modes and channels
- Supports 12 V, 1 A reverse power supply
- Expansive night view with up to 150 m IR distance

▪ Specification

Camera	
Image Sensor	1/2.8" progressive scan CMOS
Min. Illumination	color: 0.05Lux @ (F1.6, AGC ON), B/W: 0.01Lux @(F1.6, AGC ON), 0 Lux with IR
Shutter Speed	1 s to 1/30,000 s
Slow Shutter	yes
Focus	semi-auto, manual, auto
Day & Night	IR cut filter
Day/Night Switch	day, night, auto, scheduled-switch
BLC	yes
WDR	yes
HLC	yes
3D DNR	yes
Defog	yes
Regional Exposure	yes
Regional Focus	yes
Image Settings	saturation, brightness, contrast, sharpness
Image Parameters Switch	yes
White Balance	auto, ATW, sodium lamp, fluorescent lamp, indoor, outdoor, MWB, Locked WB
Zoom	25 × optical, 16 × digital
Privacy Mask	up to 24 masks, mask color configurable
SNR	> 52 dB
Lens	
Focal Length	4.8 mm to 120 mm
Zoom Speed	approx.3.6 s
FOV	Horizontal field of view: 55° to 2.4° (wide-tele), Vertical field of view: 33° to 1.4° (wide-tele), Diagonal field of view: 61.5° to 2.8° (wide-tele)
Aperture	F1.6
Illuminator	
Supplement Light Type	IR
Supplement Light Range	150 m
PTZ	
Movement Range (Pan)	360°
Movement Range (Tilt)	-15° to 90° (auto flip)
Pan Speed	pan speed: configurable from 0.1° to 120°/s; preset speed: 120°/s
Tilt Speed	tilt speed: configurable from 0.1° to 80°/s, preset speed 80°/s
Proportional Zoom	yes
Presets	300
Patrol Scan	8 patrols, up to 32 presets for each patrol
Pattern Scan	4 pattern scans
Power-off Memory	yes
Park Action	preset, pattern scan, patrol scan, auto scan, tilt scan, random scan, frame scan, panorama scan
3D Positioning	yes

PTZ Status Display	yes
Preset Freezing	yes
Scheduled Task	preset, pattern scan, patrol scan, auto scan, tilt scan, random scan, frame scan, panorama scan, dome reboot, dome adjust, aux output
Video	
Scalable Video Coding (SVC)	yes
Max. Resolution	2560 × 1440
Stream Type	main stream, sub-stream, third stream
Main Stream	50 Hz: 25 fps (2560 × 1440, 1920 × 1080, 1280 × 960, 1280 × 720) 60 Hz: 30 fps (2560 × 1440, 1920 × 1080, 1280 × 960, 1280 × 720)
Sub-Stream	50 Hz: 25 fps (704 × 576, 640 × 480, 352 × 288) 60 Hz: 30 fps (704 × 480, 640 × 480, 352 × 240)
Third Stream	50 Hz: 25 fps (1920 × 1080, 1280 × 960, 1280 × 720, 704 × 576, 640 × 480, 352 × 288) 60 Hz: 30 fps (1920 × 1080, 1280 × 960, 1280 × 720, 704 × 480, 640 × 480, 352 × 240)
Video Compression	H.265, H.264, MJPEG
H.264 Type	Baseline Profile, Main Profile, High Profile
H.265 Type	Main Profile
H.264+	yes
H.265+	yes
ROI	fixed region
Audio	
Audio Compression	G.711, G.722.1, G.726, MP2L2, PCM, MP3, AAC-LC
Audio Sampling Rate	MP2L2: 16 kHz, 32 kHz, 48 kHz, PCM: 8 kHz, 16 kHz, 32 kHz, 48kHz, MP3: 8 kHz, 16 kHz, 32 kHz, 48 kHz, AAC-LC: 16 kHz, 32 kHz, 48 kHz
Environment Noise Filtering	yes
Smart Features	
Basic Event	motion detection, alarm input, alarm output, video tampering alarm, exception
Smart Event	face detection, intrusion detection, line crossing detection, region entrance detection, region exiting detection, unattended baggage detection, object removal detection, audio exception detection
Smart Record	ANR, Dual-VCA
Alarm Linkage	preset, patrol scan, pattern scan, alarm output, sending email, notify surveillance center, upload to FTP, NAS video recording
Network	
Network Storage	NAS (NFS, SMB/ CIFS)
Protocols	IPv4/IPv6, HTTP, HTTPS, 802.1x, Qos, FTP, SMTP, UPnP, SNMP, DNS, DDNS, NTP, RTSP, RTCP, RTP, TCP/IP, UDP, IGMP, ICMP, DHCP, Bonjour, WebSocket, WebSockets
API	Open-ended API, ISAPI, Hikvision SDK, Third-party management platform, Hik-Connect, ISUP, Open Network Video Interface
User/Host	32
Security Measures	Authenticated username and password, MAC address binding, HTTPS encryption, 802.1X authenticated access, IP address filter
Client	iVMS-4200
Web Browser	Chrome 57+, Firefox 52+, Safari 12+, IE10-11
Wireless (Wi-Fi)	
Wireless Range	Up to 20 m (The performance varies based on actual environment)

Wireless (Mobile Communication)	
Frequency	DS-2DE5425IWG-4G: LTE FDD/LTE TDD/WCDMA/HSPA+/GSM/GPRS/EDGE DS-2DE5425IWG-4G(US): LTE FDD/WCDMA DS-2DE5425IWG-4G(LA): LTE FDD/LTE TDD/WCDMA/HSPA+/GSM/GPRS/EDGE DS-2DE5425IWG-4G(JP): LTE FDD/LTE TDD/WCDMA/HSPA+
Standard	DS-2DE5425IWG-4G: LTE FDD: Band 1,3,5,7,8,20,28 LTE TDD: Band 38,40,41 WCDMA/HSPA+:Band 1,5,8 GSM/GPRS/EDGE:850/900/1800MH DS-2DE5425IWG-4G(US): LTE FDD: Band 2,4,5,12,13,17,66,71 WCDMA: Band 2,4,5 DS-2DE5425IWG-4G(LA): LTE FDD: Band 1,2,3,4,5,7,8,12,17,28,66 LTE TDD: Band 38,40 WCDMA/HSPA+:Band 1,2,3,4,5,8 GSM/GPRS/EDGE:850/900/1800/1900MHz DS-2DE5425IWG-4G(JP): LTE FDD:Band1,3,8,11,18,19,21,26,28 LTE TDD:Band41 WCDMA/HSPA+:Band1,6,8,19
Interface	
On-board Storage	Built-in memory card slot, support microSD card, up to 256 GB, Built-in 256 GB eMMC storage (256 GB device model supports)
Power Output	12 VDC, max. 1000 mA
Communication Interface	RJ45, self-adaptive 10M/100M Ethernet port
Alarm Input	2 alarm inputs
Audio Input	1 audio input, 2.0 to 2.4 Vp-p, 1k Ohm±10%
Audio Output	1 audio output, line level, impedance: 600 Ω
General	
Power	12 VDC
Power Consumption and Current	Max. 20 W (including max. 7 W for IR and max. 1.6 W for heater);
Operating Conditions	-30 °C to 65 °C (-22 °F to 149 °F)
Reset	yes
Demist	yes
Material	Metal
Dimensions	∅208 mm × 344.8 mm
Weight	Approx. 3.5 kg (7.7 lb.)
Battery	
Battery Type	Lithium
Battery Voltage	10.8 V
Capacity	360 WH (90 WH for each battery)

Operating Temperature	Charging: -20 °C to 45 °C (-4 °F to 113 °F) Discharging: -20 °C to 60 °C (-4 °F to 140 °F)
Cycle Lifetime	Performance mode: 5 days, Proactive mode: 8 days, Standby mode: 80 days *in cloudy/rainy days (25 °C)
Battery Life	More than 500 cycles
Battery Weigth	Approx. 2.74 kg (6.0 lb.) (0.685 kg (1.5 lb.) for each battery)
Approval	
Protection	IP66 Standard; 6000 V Lightning Protection, Surge Protection and Voltage Transient Protection

▪ **Available Model**

- DS-2DE5425IWG-4G
- DS-2DE5425IWG-4G(US)
- DS-2DE5425IWG-4G(LA)
- DS-2DE5425IWG-4G(JP)

▪ **Dimension**

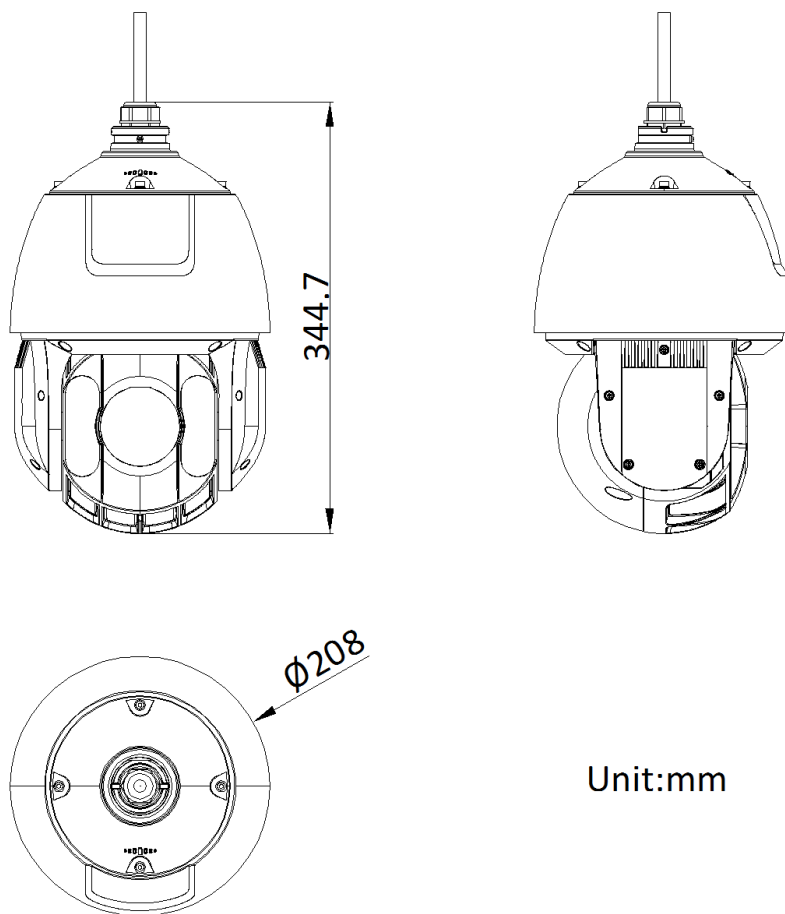

▪ **Accessory**

▪ **Optional**

DS-1661ZJ Pendant Mount	DS-1602ZJ-Corner Corner mount	DS-1602ZJ-Pole Vertical pole mount
		

Headquarters

No.555 Qianmo Road, Binjiang District,
Hangzhou 310051, China
T +86-571-8807-5998
www.hikvision.com



Follow us on social media to get the latest product and solution information.

