

DS-2CD2387G2-LSU/SL

8 MP ColorVu Strobe Light and Audible Warning Fixed Turret Network Camera

ColorVu



Hikvision ColorVu technology provides 24/7 vivid colorful images with F1.0 advanced lenses and high performance sensors. F1.0 super-aperture collects more light to produce brighter images. Advanced sensor technology can vastly improve the utilization of available light.

- High quality imaging with 8 MP resolution
- Efficient H.265+ compression technology
- Clear imaging against strong backlight due to 130 dB WDR technology
- Focus on human and vehicle targets classification based on deep learning
- 24/7 colorful imaging
- Active strobe light and audio alarm to warn intruders off
- Provide real-time security via built-in two-way audio
- Audio and alarm interface available
- Water and dust resistant (IP67)

▪ Specification

Camera	
Image Sensor	1/1.2" Progressive Scan CMOS
Max. Resolution	3840 × 2160
Shutter Speed	1/3 s to 1/100,000 s
Min. Illumination	Color: 0.0005 Lux @ (F1.0, AGC ON), 0 Lux with white light
Day & Night	24/7 Color imaging
Angle Adjustment	Pan: 0° to 360°, tilt: 0° to 75°, rotate: 0° to 360°
Lens	
Lens Type	Fixed focal lens, 2.8 and 4 mm optional
Focal Length & FOV	2.8 mm, horizontal FOV 102°, vertical FOV 52°, diagonal FOV 124° 4 mm, horizontal FOV 88°, vertical FOV 47°, diagonal FOV 104°
Lens Mount	M mount
Iris Type	Fixed
Aperture	F1.0
Depth of Field	2.8 mm: 4 m to ∞ 4 mm: 6.2 m to ∞
DORI	
DORI	2.8 mm: D: 96 m, O: 38 m, R: 19 m, I: 9 m 4 mm: D: 102 m, O: 40 m, R: 20 m, I: 10 m
Illuminator	
Supplement Light Type	White Light
Supplement Light Range	Up to 30 m
Smart Supplement Light	Yes
Video	
Main Stream	50 Hz: 25 fps (3840 × 2160, 3200 × 1800, 2688 × 1520, 1920 × 1080, 1280 × 720) 60 Hz: 24 fps (3840 × 2160) 30 fps (3200 × 1800, 2688 × 1520, 1920 × 1080, 1280 × 720)
Sub-Stream	50 Hz: 25 fps (1280 × 720, 640 × 480, 640 × 360) 60 Hz: 30 fps (1280 × 720, 640 × 480, 640 × 360)
Third Stream	50 Hz: 10 fps (1920 × 1080, 1280 × 720, 640 × 480, 640 × 360) 60 Hz: 10 fps (1920 × 1080, 1280 × 720, 640 × 480, 640 × 360)
Video Compression	Main stream: H.265/H.264/H.264+/H.265+ Sub-stream: H.265/H.264/MJPEG Third stream: H.265/H.264
Video Bit Rate	32 Kbps to 16 Mbps
H.264 Type	Baseline Profile/Main Profile/High Profile
H.265 Type	Main Profile
Bit Rate Control	CBR/VBR
Scalable Video Coding (SVC)	H.264 and H.265 encoding
Region of Interest (ROI)	1 fixed region for main stream and sub-stream
Audio	
Environment Noise Filtering	-U: Yes
Audio Sampling Rate	-U: 8 kHz/16 kHz/32 kHz/44.1 kHz/48 kHz

Audio Compression	-U: G.711ulaw/G.711alaw/G.722.1/G.726/MP2L2/PCM/MP3/AAC-LC
Audio Bit Rate	-U: 64 Kbps (G.711ulaw/G.711alaw)/16 Kbps (G.722.1)/16 Kbps (G.726)/32 to 192 Kbps (MP2L2)/8 to 320 Kbps (MP3)/16 to 64 Kbps (AAC-LC)
Network	
Simultaneous Live View	Up to 6 channels
API	Open Network Video Interface (Profile S, Profile G, Profile T), ISAPI, SDK , ISUP
Protocols	TCP/IP, ICMP, HTTP, HTTPS, FTP, DHCP, DNS, DDNS, RTP, RTSP, NTP, UPnP, SMTP, IGMP, 802.1X, QoS, IPv4, IPv6, UDP, Bonjour, SSL/TLS, PPPoE, SNMP, WebSocket, WebSockets
User/Host	Up to 32 users. 3 user levels: administrator, operator and user
Security	Password protection, complicated password, HTTPS encryption, IP address filter, Security Audit Log, basic and digest authentication for HTTP/HTTPS, TLS 1.1/1.2, WSSE and digest authentication for Open Network Video Interface
Network Storage	NAS (NFS, SMB/CIFS), auto network replenishment (ANR)
Client	iVMS-4200, Hik-Connect, Hik-Central
Web Browser	Plug-in required live view: IE 10, IE 11 Plug-in free live view: Chrome 57.0+, Firefox 52.0+, Edge 89+ Local service: Chrome 57.0+, Firefox 52.0+, Edge 89+
Image	
Wide Dynamic Range (WDR)	130 dB
SNR	≥ 52 dB
Privacy Mask	8 programmable polygon privacy masks, mask color or mosaic configurable
Day/Night Switch	Day, Night, Auto, Schedule
Image Enhancement	BLC, HLC, 3D DNR
Image Parameters Switch	Yes
Image Settings	Rotate mode, saturation, brightness, contrast, sharpness, gain, white balance adjustable by client software or web browser
Interface	
Ethernet Interface	1 RJ45 10 M/100 M self-adaptive Ethernet port
On-Board Storage	Built-in memory card slot, support microSD/microSDHC/microSDXC/TF card, up to 512 GB
Built-in Microphone	Yes
Built-in Speaker	1.5 W, 10 cm: 95 dB
Audio	1 input (line in), max. input amplitude: 3.3 Vpp, input impedance:4.7 KΩ, interface type: non-equilibrium 1 output (line out), max.output amplitude: 3.3 Vpp, output impedance: 100 Ω, interface type: non-equilibrium
Alarm	1 input, 1 output (max. 24 VDC, 1 A)
Reset Key	Yes
Event	
Basic Event	Motion detection (support alarm triggering by specified target types (human and vehicle)), video tampering alarm, exception (network disconnected, IP address conflict, illegal login, HDD full, HDD error)
Smart Event	Line crossing detection, intrusion detection, region entrance detection, region exiting detection (support alarm triggering by specified target types (human and vehicle)), scene change detection

Linkage	Upload to NAS/memory card/FTP, notify surveillance center, trigger record, trigger capture, send email
Deep Learning Function	
Face Capture	Yes
General	
Power	12 VDC \pm 25%, 0.63 A, max. 8.5 W, \varnothing 5.5 mm coaxial power plug, reverse polarity protection PoE: 802.3af, Class 3, 36 V to 57 V, 0.24 A to 0.15 A
Material	Cover: metal, main body: metal
Dimension	\varnothing 138.3 mm \times 120.1 mm (\varnothing 5.4" \times 4.7")
Package Dimension	170 mm \times 170 mm \times 150 mm (6.7" \times 6.7" \times 5.9")
Weight	Approx. 900 g (2.0 lb.)
With Package Weight	Approx. 1190 g (2.6 lb.)
Storage Conditions	-30 °C to 60 °C (-22 °F to 140 °F). Humidity 95% or less (non-condensing)
Startup and Operating Conditions	-30 °C to 60 °C (-22 °F to 140 °F). Humidity 95% or less (non-condensing)
Language	33 languages English, Russian, Estonian, Bulgarian, Hungarian, Greek, German, Italian, Czech, Slovak, French, Polish, Dutch, Portuguese, Spanish, Romanian, Danish, Swedish, Norwegian, Finnish, Croatian, Slovenian, Serbian, Turkish, Korean, Traditional Chinese, Thai, Vietnamese, Japanese, Latvian, Lithuanian, Portuguese (Brazil), Ukrainian
General Function	Anti-flicker, heartbeat, mirror, password reset via e-mail, pixel counter
Approval	
EMC	FCC: 47 CFR Part 15, Subpart B CE-EMC: EN 55032: 2015, EN 61000-3-2: 2019, EN 61000-3-3: 2013 + A1: 2019, EN 50130-4: 2011 + A1: 2014 RCM: AS/NZS CISPR 32: 2015 IC: ICES-003: Issue 7 KC: KN32: 2015, KN35: 2015
Safety	UL: UL 62368-1 CB: IEC 62368-1: 2014 + A11 CE-LVD: EN 62368-1: 2014/A11: 2017
Environment	CE-RoHS: 2011/65/EU WEEE: 2012/19/EU Reach: Regulation (EC) No 1907/2006
Protection	IP67: IEC 60529-2013

▪ **Typical Application**

Hikvision products are classified into three levels according to their anti-corrosion performance. Refer to the following description to choose for your using environment.

This model has NO SPECIFIC PROTECTION.

Level	Description
Top-level protection	Hikvision products at this level are equipped for use in areas where professional anti-corrosion protection is a must. Typical application scenarios include coastlines, docks, chemical plants, and more.
Moderate protection	Hikvision products at this level are equipped for use in areas with moderate anti-corrosion demands. Typical application scenarios include coastal areas about 2 kilometers (1.24 miles) away from coastlines, as well as areas affected by acid rain.
No specific protection	Hikvision products at this level are equipped for use in areas where no specific anti-corrosion protection is needed.

▪ **Available Model**

DS-2CD2387G2-LSU/SL (2.8/4 mm)



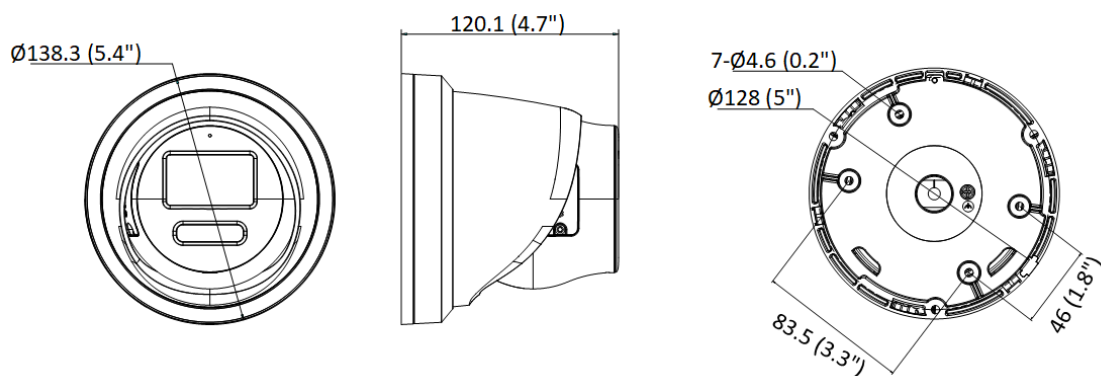



▪ **Dimension**



Unit: mm (inch)

▪ **Accessory**

▪ **Optional**

DS-1280ZJ-PT6 Junction Box	DS-1271ZJ-140 Pendant Mount	DS-1276ZJ-SUS Corner Mount	DS-1273ZJ-140B Wall Mount	DS-1275ZJ-SUS Vertical Pole Mount
				
DS-1273ZJ-140 Wall Mount				
				

Headquarters

No.555 Qianmo Road, Binjiang District,
 Hangzhou 310051, China
 T +86-571-8807-5998
 www.hikvision.com



Follow us on social media to get the latest product and solution information.

