

ASTERION lead-acid batteries of the CGD series are manufactured according to AGM technology (electrolyte absorbed in a fiberglass separator).

As part of the active mass, a carbon addition in the form of graphene is used what makes ASTERION CGD batteries resistant to deep discharges and high temperature stability under adverse operating conditions. This series also features an increased number of charge/discharge cycles and duration of operation in heavy-duty systems based on renewable energy sources.

The batteries are designed to operate both in buffer and cyclic modes. Recommended for use in autonomous power systems, as well as in conjunction with systems based on alternative energy sources.



Battery construction

Element	Positive plate	Negative plate	Case	Lid	Valve	Terminal	Separator	Electrolyte
Material	Lead dioxide	Lead	ABS		Rubber	Copper	Fiberglass	Acid

Specifications

Nominal voltage.....	12 V
Cell.....	6
Design life.....	15 years
Nominal capacity (25°C)	
10 hours rate (10 A; 1,8 V/cell).....	100 Ah
5 hours rate (18,3 A; 1,75 V/cell).....	91,5 Ah
1 hours rate (68 A; 1,65 V/cell).....	68 Ah
Self-discharge.....	3% capacity per month 20°C
Internal resistance (25°C).....	5 mΩ

Operating temperature range

Discharge.....	-20÷60°C
Charge.....	-10÷60°C
Storage.....	-20÷60°C
Maximum discharge current (25°C).....	1000A (5sec)
Cycle mode (2,35÷2,4 V/cell)	
Max.charge current.....	50-100 A*
Temperature correction factor.....	30 mV/°C
Standby mode (2,25÷2,3 V/cell)	
Temperature correction factor.....	20 mV/°C

*Charging with currents from 50A to 100A is possible by monitoring of battery temperature up to 25°C

Application

- Uninterruptible power supplies
- Communication and telecommunication systems
- Solar and wind power systems
- Autonomous power supply systems
- Other energy storage systems

Layout
B

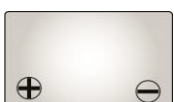

Terminal type
Insert Ø8 mm

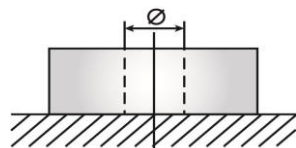

Performance & characteristics

- The presence of carbon in the form of graphene in the composition of the paste;
- Long service life;
- Deep discharge stability;
- Temperature stability of the battery;
- Excellent performance at low and high ambient temperatures;
- Unsurpassed number of charge/discharge cycles;
- Charge with high currents with minimal loss of capacity;
- A universal solution for any battery life.

Dimensions (±2mm)

Length, mm.....	330
Width, mm.....	173
Height, mm.....	212
Height over terminals, mm.....	220
Weight (±3%), kg.....	30

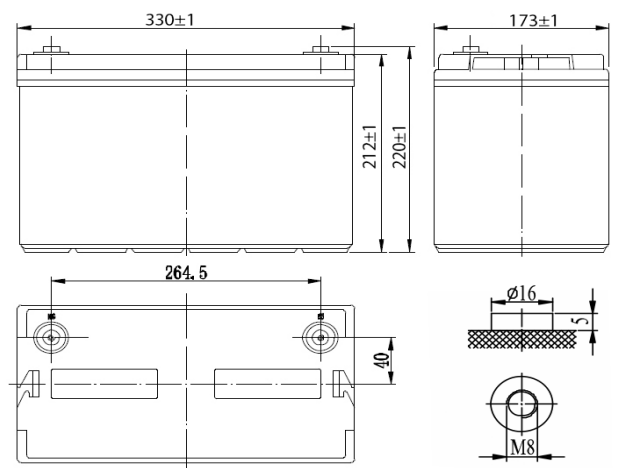

Discharge Constant Current, A (25°C)

V/cell	15 min	30 min	45 min	1 h	2 h	3 h	5 h	8 h	10 h
1,60	201	125	91,0	74,0	39,0	27,6	19,5	12,9	10,6
1,65	187	121	85,7	68,0	36,6	26,2	18,8	12,7	10,4
1,70	175	118	84,0	67,0	35,8	25,8	18,5	12,5	10,3
1,75	164	115	81,7	65,0	32,9	25,1	18,3	12,4	10,1
1,80	151	103	75,0	61,0	29,5	23,8	17,7	12,1	10,0

Discharge Constant Power, W/cell (25°C)

V/cell	15 min	30 min	45 min	1 h	2 h	3 h	5 h	8 h	10 h
1,60	388	241	178	147	78,1	57,7	36,3	25,1	22,1
1,65	350	231	160	125	75,4	53,6	35,7	24,9	21,4
1,70	342	229	158	124	74,4	52,8	35,2	24,6	21,1
1,75	349	228	165	123	72,9	52,5	34,7	24,3	20,2
1,80	305	213	149	117	70,3	50,3	34,0	24,0	19,1

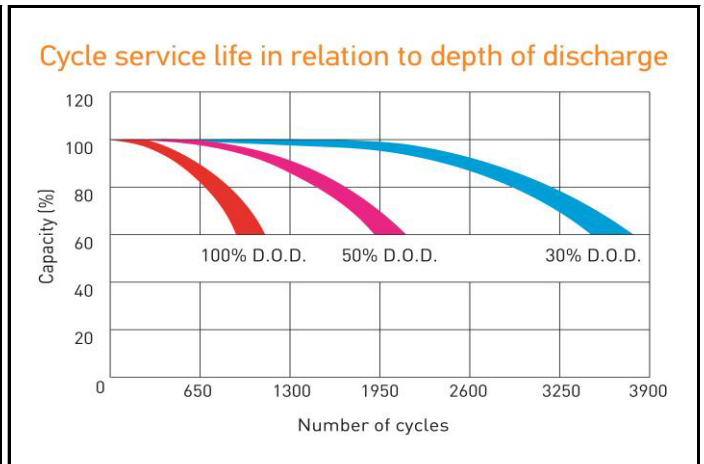
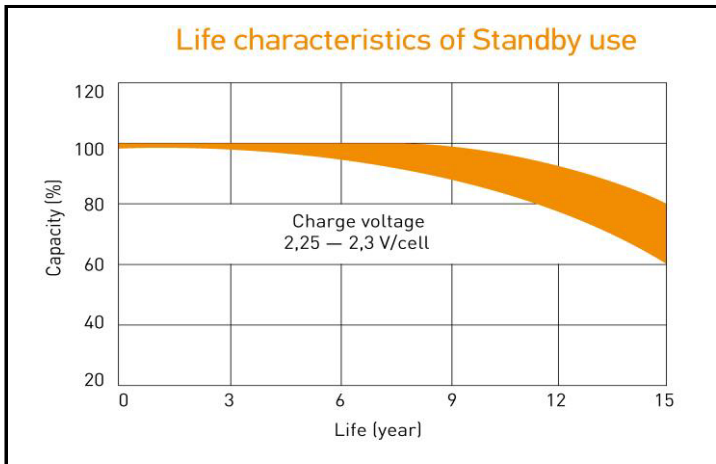
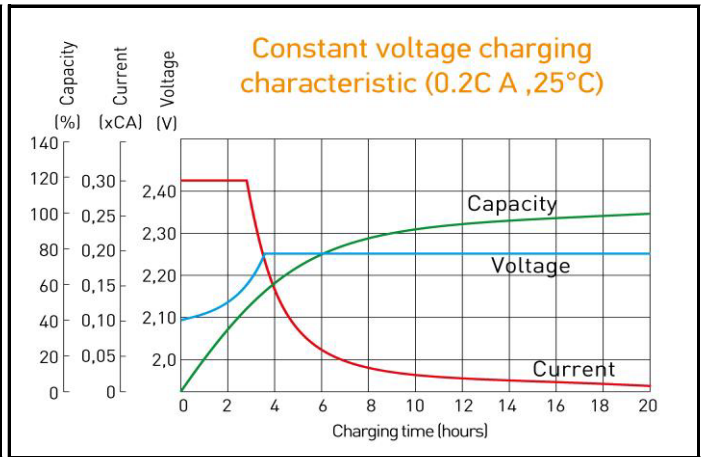
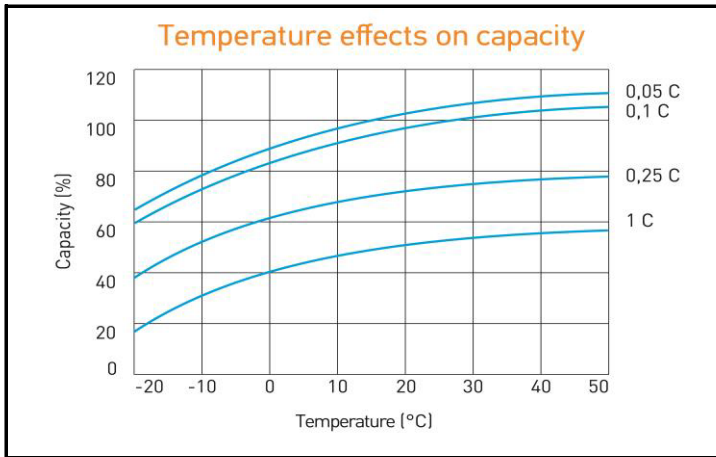

ALL DATA IS SUBJECT TO CHANGE WITHOUT NOTICE