

LYNX Pro LH25 Handheld Thermal Monocular Camera



HIKMICRO LYNX Pro LH25 handheld thermal monocular camera is equipped with a 384 × 288 infrared detector and a 1280 × 960 LCOS display. It supports functions of observation, distance measurement, Wi-Fi hot spot, and so on. The high-sensitivity built-in thermal detector provides you with clear view even in total darkness. The monocular is mainly applied to scenarios such as patrolling, searching and rescuing, hiking, travel, and hunting, etc.

Key Features

- 384 × 288 resolution, 12 μm, high sensitivity detector
- Adaptive AGC, DDE, 3D DNR, NETD less than 35 mk (@25°C), F#=1.0
- 1280 × 960 resolution 0.4-inch LCOS display
- Built-in rechargeable lithium battery
- Up to 7.5 hours continuous running
- Wi-Fi hot spot
- Type-C Interface

Specification

Thermal Module	
Image Sensor	Vanadium Oxide Uncooled Focal Plane Arrays
Max. Resolution	384 × 288
Pixel Interval	12 μm
Response Waveband	8 μm to 14 μm
NETD	≤ 35 mk (@25°C), F#=1.0
Lens (Focal Length)	25 mm
Field of View	10.5° × 7.9° (H × V)
Digital Zoom	1 ×, 2 ×, 4 ×, 8 ×
Aperture	F1.0
Magnification	2.45 to 19.6
Image Display	
Monitor	0.4 inch, LCOS, 1280 × 960
FFC (Flat Field Correction)	Auto, Manual, External Correction
Palettes	Black Hot, White Hot, Red Hot, Fusion
Frame Frequency	50 Hz
Smart Function	
Wi-Fi Hot Spot	Yes
Standby Mode	Yes
Detection Range	1180 m
System	
Storage	Built-in memory module (8 GB)
Record Video	Yes
Capture Snapshot	Yes
Power Supply	
Battery Type	Lithium battery
Battery Operating Time	7.5 hours continuous running with Wi-Fi hot spot function off (@25°C) 6 hours continuous running with Wi-Fi hot spot function on (@25°C)
Battery Capacity Display	Yes
General	
Power	5 VDC/2 A, 1.5 W, Type-C Interface
Working Temperature	-20 °C to 55 °C (-4 °F to 131 °F)
Protection Level	IP67
Dimension	171 mm × 61 mm × 57 mm (6.73" × 2.40" × 2.24")
Weight	300 g (0.66 lb)

Accessory

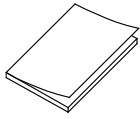

Quick Start Guide
(x1)

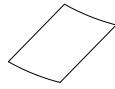

Non-dust Cloth (x1)

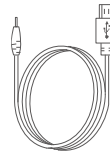

USB Cable (x1)



Protective Bag (x1)



Wrist Strap (x1)

Available Model

HM-TS03-25XG/W-LH25

Dimension

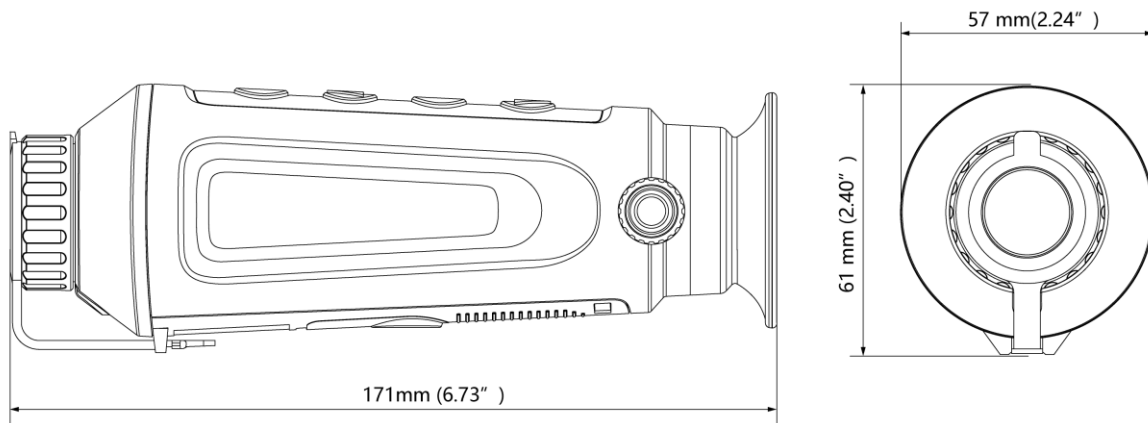

COMPLIANCE NOTICE: The thermal series products might be subject to export controls in various countries or regions, including without limitation, the United States, European Union, United Kingdom and/or other member countries of the Wassenaar Arrangement. Please consult your professional legal or compliance expert or local government authorities for any necessary export license requirements if you intend to transfer, export, re-export the thermal series products between different countries.