

DS-K1T673DWX Face Recognition Terminal



Face recognition terminal is a kind of access control device. It can be widely applied in multiple scenarios, such as enterprises, stations, dwellings, factories, schools, campus and so on.

- 7-inch LCD touch screen, 2 Mega pixel wide-angle lens
- Recognition distance: 0.3 to 3 m
- Face recognition duration < 0.2 s/User
- Face recognition accuracy rate ≥ 99%
- Built-in Mifare card, Felica card, and DESfire card reading module (Presents card on the screen to authenticate)
- Face mask detection
- 10,000 face capacity, 10,000 fingerprint capacity (With fingerprint module), 50,000 card capacity, and 150,000 event capacity
- Supports ISAPI, ISUP 5.0, TCP/IP (IPv4 and IPv6)
- Supports single person and multiple people (Up to 5 people) recognition

▪ Specification

System	
Operation system	Linux
Display	
Size	7-inch
Type	Touch screen
Video	
FOV	HFOV= 75.5°; VFOV= 41.5°; DFOV= 87°
Pixel	2 MP
Lens	Dual-lens
Video standard	PAL (Default)/NTSC
Network	
Wired network	Support 10/100/1000 Mbps self-adaptive
Wi-Fi	Support
Interface	
Alarm input	1
Alarm output	1
USB	1 (For Module)
Audio Output Interface	1 (3.5 mm)
Network interface	1
RS-485	1
Wiegand	1
Lock output	1
Exit button	1
Door contact input	1
TAMPER	1
Capacity	
Card capacity	50,000
Face capacity	10,000
Event capacity	150,000
Authentication	
Face recognition accuracy rate	≥ 99%
Card type	Mifare 1 card, DESfire card, Felica card
Card reading distance	0 to 3 cm
Card reading duration	< 1 s
Face recognition duration	< 0.2 s per person
Face recognition distance	0.3 to 3 m
Function	
Two-way audio	Support
Time synchronization	Support
Face anti-spoofing	Support
Live view	Support
Audio prompt	Support
General	
Power supply	12 VDC to 24 VDC/2 A

Working temperature	-30 °C to 60 °C (-22 °F to 140 °F)
Working humidity	0 to 90% (no condensing)
Protective level	IP65
Dimensions	110.5 mm × 209.2 mm × 24 mm (4.35" × 8.24" × 0.94")
Language	English, Spanish (South America), Arabic, Thai, Indonesian, Russian, Vietnamese, Portuguese (Brazil), Japanese, Korean
Weight	Gross Weight: 1.06 kg (2.34 lb) Net Weight: 0.57 kg (1.26 lb)

▪ Available Model



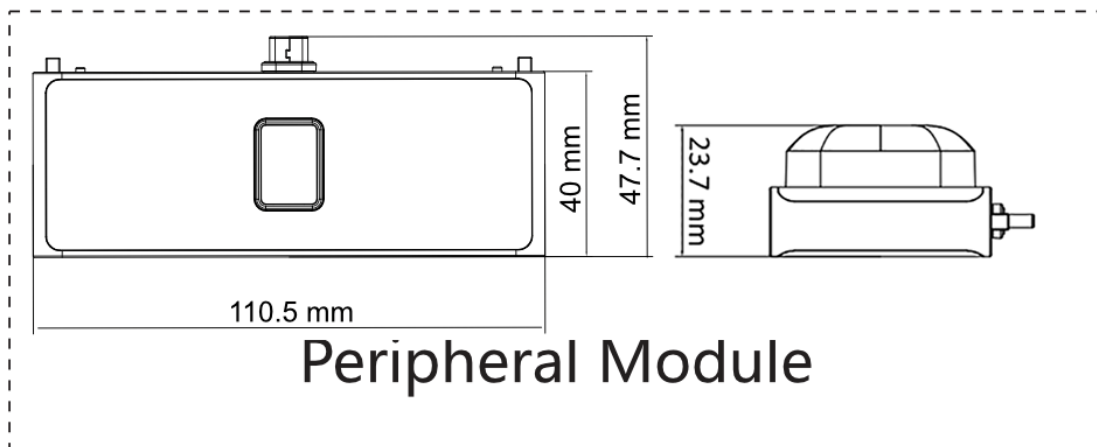
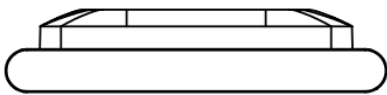
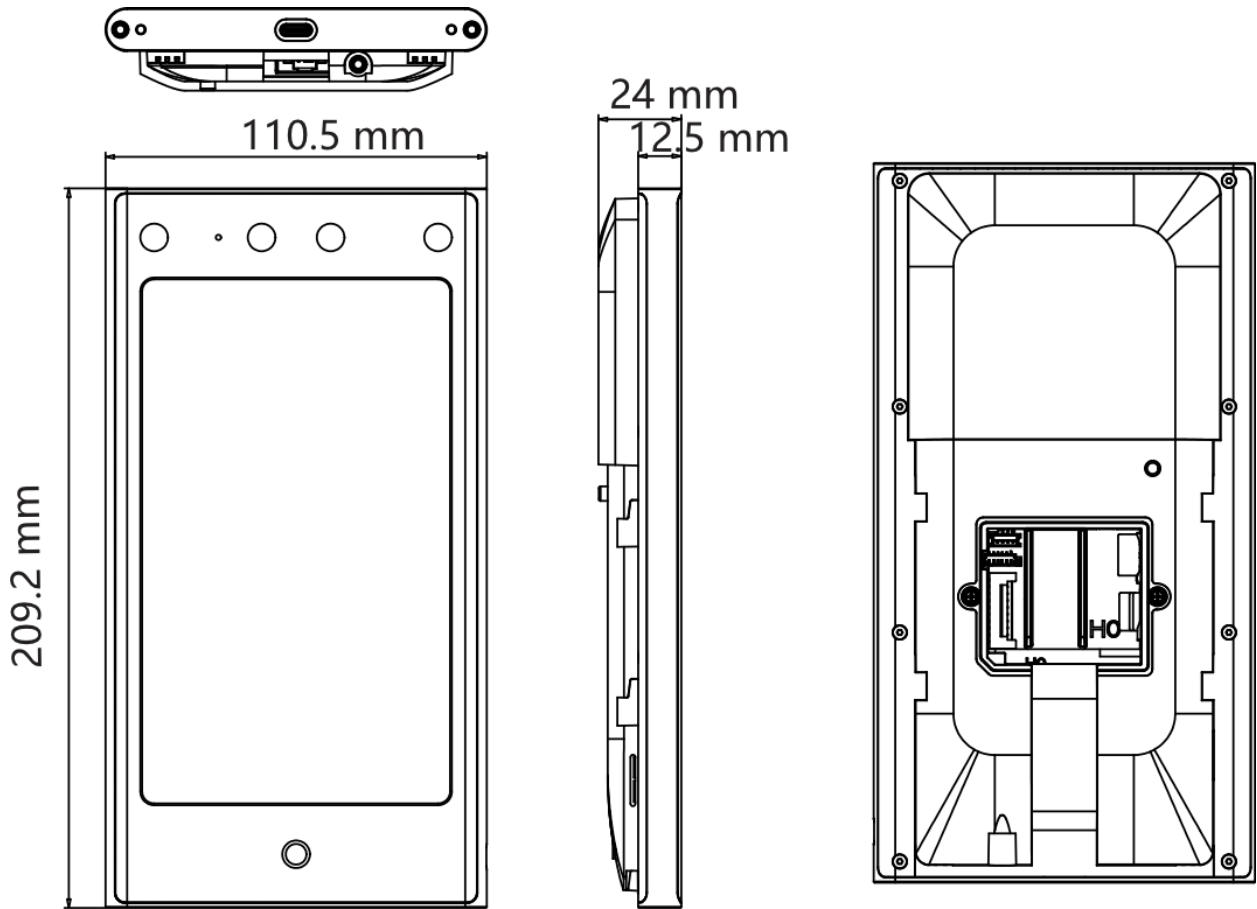

DS-K1T673DWX

▪ Dimension



▪ **Accessory**

▪ **Optional**

DS-KAB673-BQR	DS-KAB673-FB	DS-KAB673-B	DS-KAB673-FBQR	DS-K3AP122
				

Headquarters

No.555 Qianmo Road, Binjiang District,
Hangzhou 310051, China
T +86-571-8807-5998
www.hikvision.com



Follow us on social media to get the latest product and solution information.

