

8-Port 10/100TX 802.3at PoE + 2-Port Gigabit TP/SFP Combo Desktop Switch with PoE LCD Monitor



Just "Plug and Watch" for a Quick Solution

PLANET FGSD-1022VHP is an ideal **Plug and Watch Power over Ethernet** solution which provides quick installation, real-time PoE work status monitoring and immediate troubleshooting through its unique LCD display to improve work efficiency and quality without any PC or software required.



PLANET FGSD-1022VHP is equipped with **8 10/100BASE-TX ports** with each port taking up 30 watts of PoE+ power, and **2 Gigabit TP/SFP combo** interfaces with inner power system. With a total PoE+ power budget of **120 watts** and non-blocking data switching performance, the FGSD-1022VHP can fulfill the demand of sufficient PoE power for HD IP surveillance. It offers a desktop-sized, reliable and visible power solution for small businesses and system integrators deploying Power over Ethernet networks.

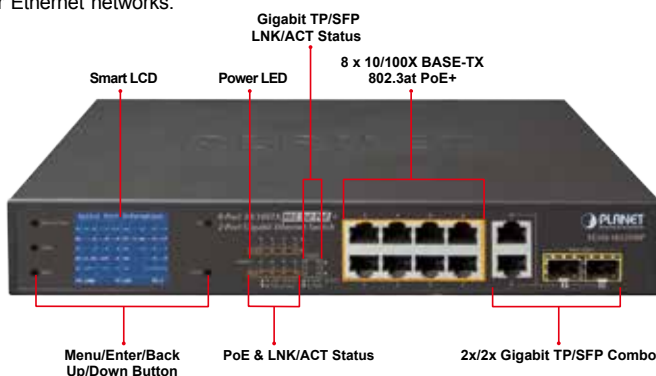

Smart and Intuitive LCD Control

PLANET FGSD-1022VHP provides an intuitive color panel on its front panel that facilitates the Ethernet management and PoE PD management. They greatly promote management efficiency in large-scale networks for enterprises, hotels,

Physical Port

- 8-port 10/100BASE-TX RJ45 copper
- 2 10/100/1000BASE-T TP interfaces and 2 1000BASE-X mini-GBIC SFP shared combo interfaces

Power over Ethernet

- Complies with IEEE 802.3af/at Power over Ethernet end-span PSE
- Up to 8 ports of IEEE 802.3af/802.3at devices powered
- Supports PoE power up to 32 watts for each PoE port
- Each port supports 52V DC power to PoE powered device
- 120-watt PoE budget
- Auto detects powered device (PD)
- Circuit protection prevents power interference between ports
- Remote power feeding up to 100m in standard mode and 250m in extend mode

Smart LCD

- The LCD switch features "Standard", "VLAN" and "Extend" mode selection; the "Extend" mode features 30-watt PoE transmit distance of 250m at speed of 10Mbps and VLAN isolation
- The LCD switch is able to isolate ports to prevent broadcast storm and defend DHCP spoofing
- Power low-voltage, power over-voltage and PSE over-temperature protection
- Screen saver, fan control, factory default and save configuration
- PoE management
 - Total PoE power budget control
 - Per port PoE function enable/disable
 - PoE port power feeding priority
 - Per PoE port power limitation
 - PD alive check

Switching

- Hardware-based 10/100Mbps auto-negotiation and auto MDI/MDI-X

shopping malls, government buildings and other public areas, and feature the following special management and status functions:

- PoE management and status
- Port management and status
- Switch mode: Standard, VLAN, Extend
- Budget and bandwidth control
- PD alive check
- Maintenance: Screen saver, fan control, factory default and save configuration

Switch Port Information					
01	30.3W	--M	-10M	06	---
02	---	---	---	07	8.3W
03	---	---	---	08	---
04	15.4W	-10M	---	09	---
05	-OFF-	---	---	10	223M
PB:120W		TP:54W		PD:3	

Main Menu	
01	Switch Mode
02	Budget Control
03	PSE Port Priority
04	PSE Port Enable
05	PD Type
06	Alive Check
07	Bandwidth
08	Fan Control

Switch Mode	
Options:	
Standard	<
VLAN	
Extend	

PSE Port Enable	
Port	Status
01	Enable <
	Disable
Current Setting: Enable	
<UP>/<Down>; Select	
<Enter>; Confirm <Back>; Return	

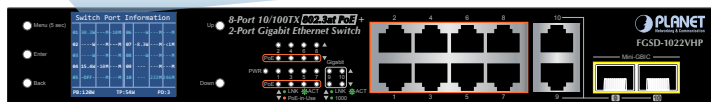

- Flow control for full duplex operation and back pressure for half duplex operation
- 9216bytes packet size
- Integrates address look-up engine, supporting 8K absolute MAC addresses
- IEEE 802.1Q VLAN transparency
- Automatic address learning and address aging

Hardware

- 12-inch desktop size, 1U height, rack mountable
- 2-inch color LCD with smart management functions
- LED indicators for system power, per port PoE ready and PoE activity, speed, Link/Act
- 1 silent fan to provide stable and efficient power performance
- Supports Energy-Efficient Ethernet (EEE) function (IEEE 802.3az)
- Supports contact discharge of ±4KV DC and air discharge of ±6KV DC for Ethernet ESD protection
- Supports ±4KV surge immunity

Standard, VLAN and Extend Operation Modes Offered

PLANET FGSD-1022VHP provides Standard, VLAN and Extend operation modes. The FGSD-1022VHP operates as a normal IEEE 802.3af/at PoE Switch in the Standard operation mode. The VLAN operation mode features the port-based VLAN function that can help to prevent the IP camera's multicast or broadcast storm from influencing each other.

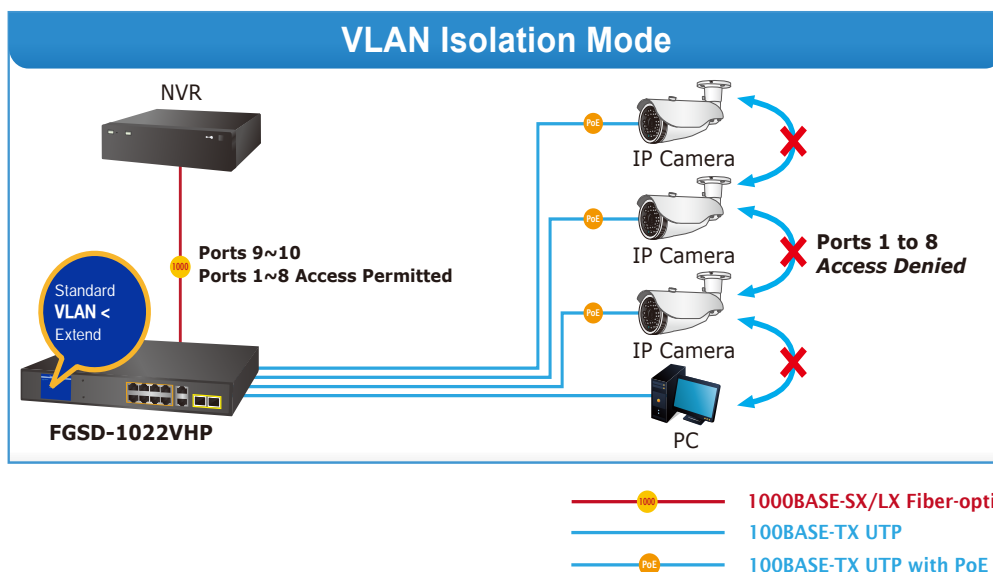

In the Extend operation mode, the FGSD-1022VHP operates on a per-port basis at 10Mbps duplex operation but can support 30-watt PoE power output over a distance of up to 250 meters overcoming the 100m limit on Ethernet UTP cable. With this brand-new feature, the FGSD-1022VHP provides an additional solution for 802.3at/af PoE distance extension, thus saving the cost of Ethernet cable installation. Its VLAN isolation function isolates ports so as to prevent broadcast storm and defend DHCP spoofing in the Extend operation mode.

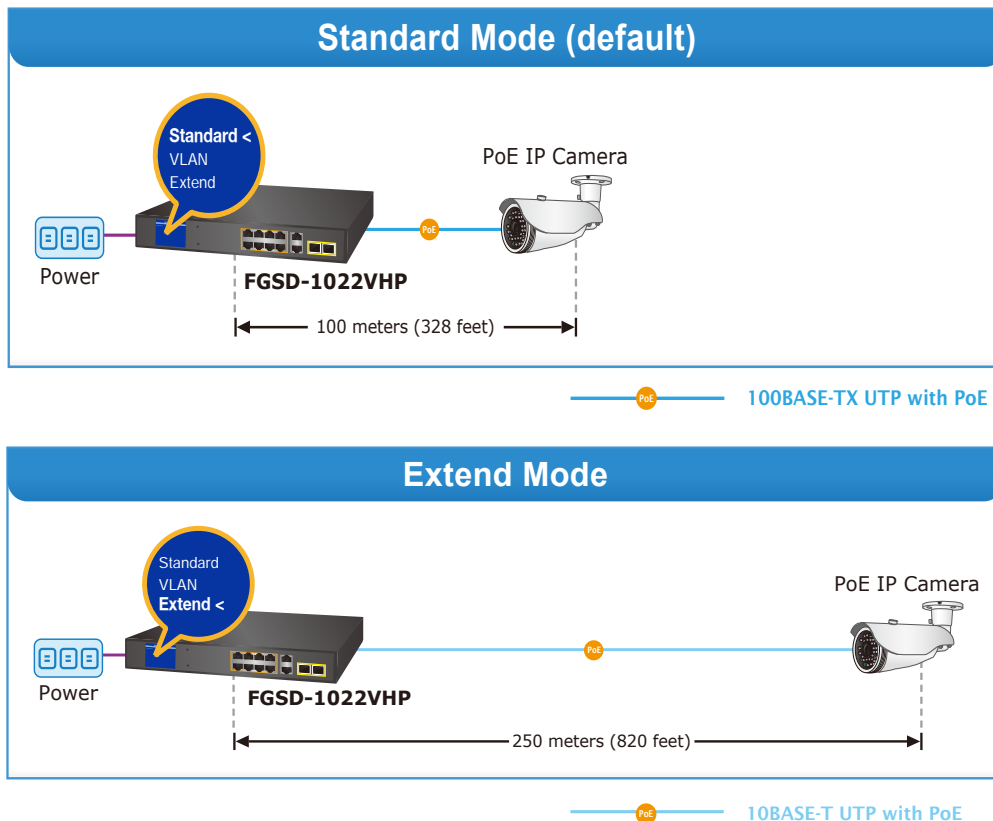

Flexible Extension Solution

PLANET FGSD-1022VHP provides 2 extra Gigabit TP/SFP combo interfaces supporting 10/100/1000BASE-T RJ45 copper for surveillance network devices such as NVR, video streaming server or NAS to facilitate surveillance management. Or through these Gigabit speed fiber SFP slots, the 1000BASE-SX/LX SFP (Small Form-factor Pluggable) fiber transceiver is inserted to be uplinked to a backbone switch and monitoring center over a long distance. The distance can be extended from 550m to 2km (multi-mode fiber), even going up to 10/20/30/40/50/60/70/120km (single-mode fiber or WDM fiber). They are well suited for applications within the enterprise data centers and distributions.

Robust Protection

PLANET FGSD-1022VHP provides contact discharge of $\pm 4\text{KV}$ DC and air discharge of $\pm 6\text{KV}$ DC for Ethernet ESD protection. It also supports $\pm 4\text{KV}$ surge immunity to improve product stability and protects users' networks from devastating ESD attacks, making sure the flow of operation does not fluctuate.

Easy Installation and Cable Connection

As data and power are transmitted over one cable, the FGSD-1022VHP does not need a second cable and electrical outlets on the wall, ceiling or any unreachable place. Thus, it helps to lower the installation costs and simplify the installation effort. All the RJ45 copper interfaces of the FGSD-1022VHP support 10/100Mbps auto-negotiation for optimal speed detection through RJ45 Category 6, 5 or 5e cable. It also supports standard auto-MDI/MDI-X that can detect the type of connection to any Ethernet device without requiring special straight-through or crossover cables.

Applications

Perfectly-integrated Solution for PoE IP Camera and NVR System

With its 5.6Gbps high-performance switch architecture and 120-watt PoE power budget, the recorded video files from the 8 PoE IP cameras powered by the FGSD-1022VHP are saved in the 8-channel NVR systems or surveillance software in the monitoring center for possible backup references.

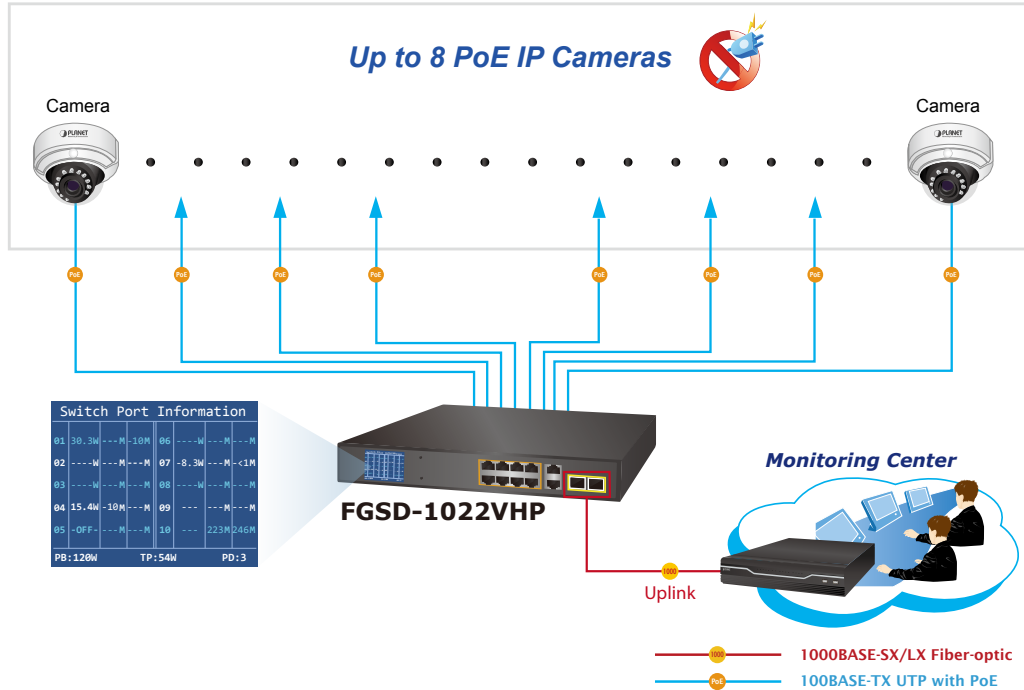

Ideal PoE Switch for All Enterprises

Providing sixteen 802.3at PoE+ in-line power interfaces, the FGSD-1022VHP can easily build a power that centrally controls IP phone system, IP camera system and wireless AP group for enterprises. Cameras can be installed around the corner in the company or campus for surveillance demands. Without the need for power sockets, the FGSD-1022VHP makes the installation of cameras easier and more efficient.

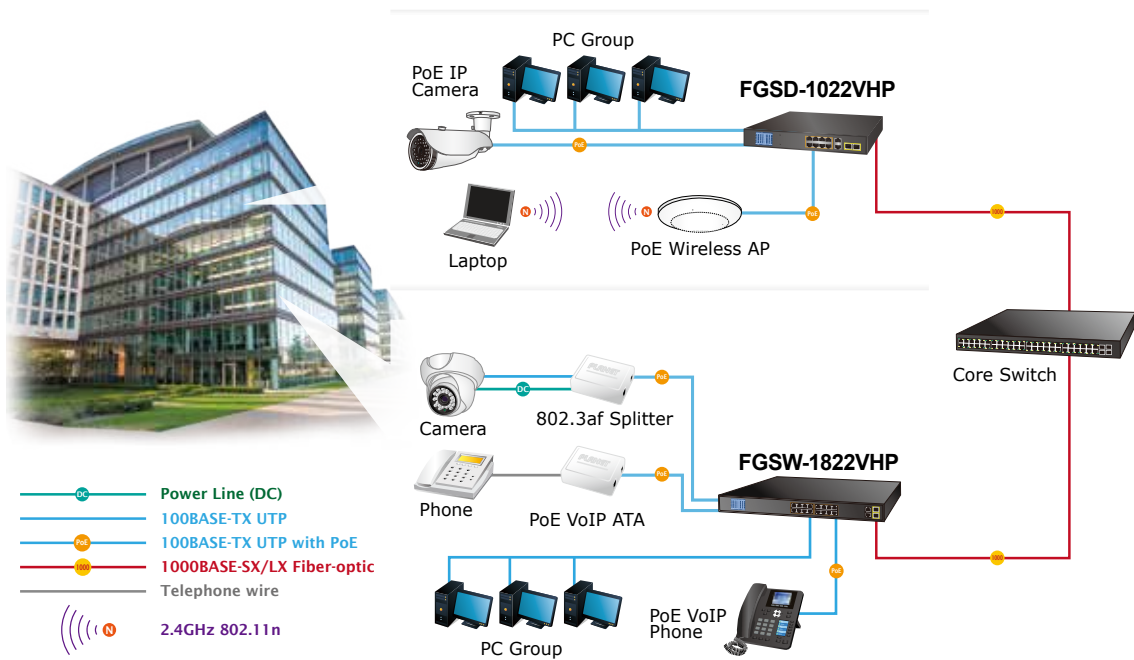

Specifications

Product	FGSD-1022VHP
Hardware Specifications	
802.3af/802.3at PoE Injector Port	8
10/100BASE-TX MDI/MDIX Ports	8
10/100/1000BASE-T MDI/MDIX Ports	2 (Combo)
1000BASE-X SFP/mini-GBIC Slots	2 (Combo)
Switch Architecture	Store-and-Forward
Switch Fabric	5.6Gbps/non-blocking
Switch Throughput@64 bytes	4.17Mpps@64 bytes
MAC Address Table	8K entries
Maximum Frame Size	9216 bytes
Flow Control	IEEE 802.3x pause frame for full duplex; back pressure for half duplex
LED	System: Power (Green) 10/100BASE-TX RJ45 Interfaces: 10/100Mbps LNK/ACT (Green) PoE-in-Use (Orange) 1000BASE-X SFP Interfaces: LNK/ACT (Green) 1000BASE-T TP Interfaces: LNK/ACT (Green) 1000Mbps (Green)
LCD Monitor (W x D)	40.6mm x 30.5mm, 2-inch
Buttons	Menu, Enter, Back, Up and Down
Dimensions (W x D x H)	180 x 280 x 44mm (1U height)
Enclosure	Metal
Weight	1.8kg
Power Requirements	100~240V AC, 50/60Hz, 2.5A max.
Power Consumption/Dissipation	Max. 130watts/446 BTU
Thermal Fan	1
ESD Protection	Contact Discharge of ±4KV DC Air Discharge of ±6KV DC
Surge Immunity	±4KV
Power over Ethernet	
PoE Standard	IEEE 802.3af Power over Ethernet/PSE IEEE 802.3at Power over Ethernet Plus/PSE
PoE Power Supply Type	End-span
PoE Power Output	Per port 54V DC, 300mA. max. 15.4 watts (IEEE 802.3af) Per port 54V DC, 600mA. max. 30 watts (IEEE 802.3at)
Power Pin Assignment	1/2 (+), 3/6 (-)
PoE Power Budget	120 watts
Max. Number of Class 2 PDs	8
Max. Number of Class 3 PDs	8
Max. Number of Class 4 PDs	4
Standards Conformance	
Regulatory Compliance	FCC Part 15 Class A, CE
Standards Compliance	IEEE 802.3 10BASE-T IEEE 802.3u 100BASE-TX IEEE 802.3ab Gigabit 1000BASE-T IEEE 802.3z Gigabit SX/LX IEEE 802.3x Flow control and back pressure IEEE 802.3af Power over Ethernet IEEE 802.3at Power over Ethernet Plus IEEE 802.3az Energy Efficient Ethernet (EEE)
Environment	
Operating	Temperature: -10 ~ 60 degrees C Relative Humidity: 10 ~ 90% (non-condensing) * Temperature: <40 degrees C; Humidity: <90% Temperature: >40 degrees C; Humidity: <50%
Storage	Temperature: -10 ~ 70 degrees C Relative Humidity: 5 ~ 95% (non-condensing)

Drawing

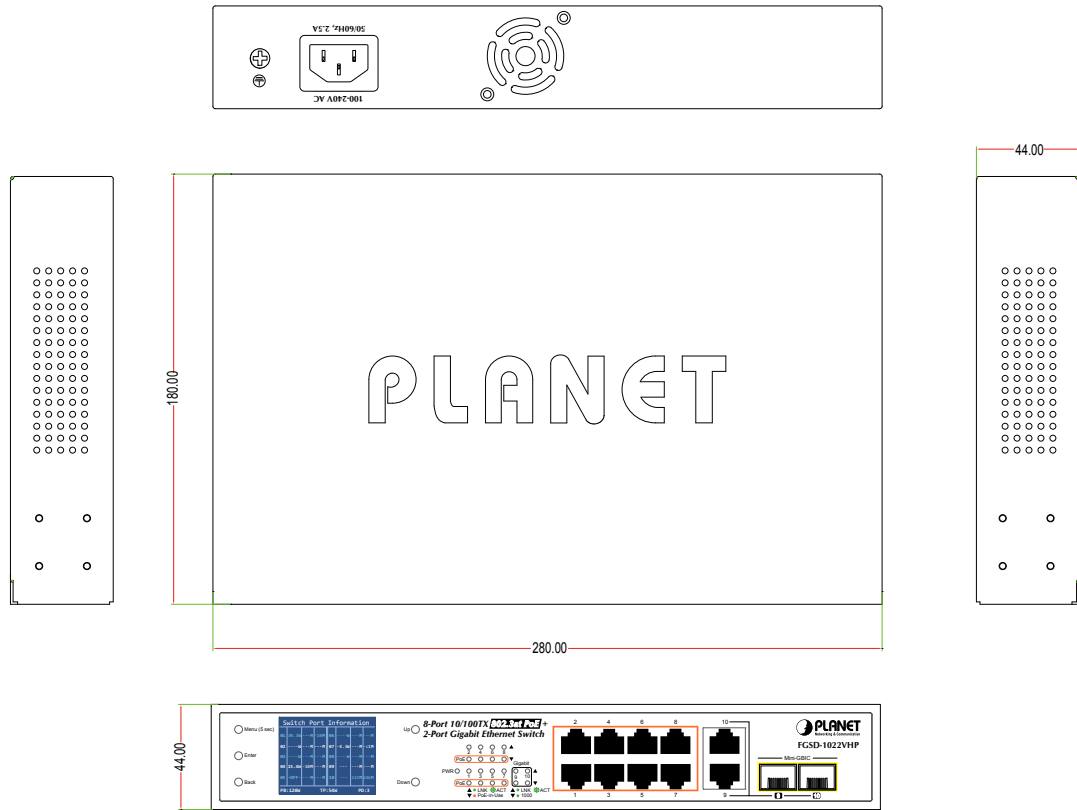

Dimensions (unit = mm)

Ordering Information

FGSD-1022VHP	8-Port 10/100TX 802.3at PoE + 2-Port Gigabit TP/SFP Combo Desktop Switch with PoE LCD Monitor
--------------	---

Related PoE Products

GSD-1222VHP	8-Port 10/100/1000T 802.3at PoE + 2-Port 10/100/1000T + 2-Port 1000X SFP Ethernet Switch with PoE LCD Monitor (120W)
FGSW-1822VHP	16-Port 10/100TX 802.3at PoE + 2-Port Gigabit TP/SFP Combo Ethernet Switch with PoE LCD Monitor (300W)
FGSW-2622VHP	24-Port 10/100TX 802.3at PoE + 2-Port Gigabit TP/SFP Combo Ethernet Switch with PoE LCD Monitor (300W)
GSW-1820VHP	16-Port 10/100/1000T 802.3at PoE + 2-Port Gigabit SFP Ethernet Switch with PoE LCD Monitor (300W)
GSW-2620VHP	24-Port 10/100/1000T 802.3at PoE + 2-Port 1000X SFP Gigabit Ethernet Switch with PoE LCD Monitor (300W)
HDP-1100PT	720p SIP Door Phone with PoE
HDP-5240PT	720p SIP Multi-unit Video Door Phone with RFID and PoE
HDP-5260PT	720p SIP Multi-unit Apartment Vandalproof Door Phone with RFID and PoE
ICA-2250VT	Industrial PoE Plus Outdoor IR IP Camera
ICA-3250	1080p IR Bullet PoE IP Camera
ICA-4200V	Full HD 20M IR Vari-focal Dome IP Camera
ICA-4250	1080p IR Dome PoE IP Camera
ICA-E3550V	5 Mega-pixel Bullet IR PoE IP Camera with Extended Support
ICA-E5550V	5 Mega-pixel Vandalproof IR PoE IP Camera with Extended Support
ICA-E6260	2 Mega-pixel PoE Plus Speed Dome IP Camera with Extended Support
ICA-E8550	5 Mega-pixel Outdoor IR PoE Fisheye IP Camera with Extended Support
ICA-M3380P	H.265 3 Mega-pixel Bullet IR IP Camera with Remote Focus and Zoom

ICA-M4320P	H.265 3 Mega-pixel IR IP Camera with Remote Focus and Zoom
ICA-M5380P	H.265 3 Mega-pixel Vandalproof IR IP Camera with Remote Focus and Zoom
POE-162S	IEEE 802.3at Gigabit High Power over Ethernet Splitter
POE-E201	IEEE 802.3at Power over Ethernet Extender
WAP-252N	2.4GHz 802.11n 300Mbps Outdoor Wireless AP
WNAP-C3220A	300Mbps 802.11n Ceiling-mount Wireless Access Point
WDAP-C1750	1750Mbps 802.11ac Dual Band Ceiling-mount Enterprise Wireless Access Point
WNAP-W2201A	300Mbps 802.11n In-Wall Wireless Access Point (EU Type)
WDAP-802AC	1200Mbps Dual Band 802.11ac Outdoor Wireless AP
VIP-1120PT	High Definition Color PoE IP Phone
VIP-2140PT	High Definition Color PoE IP Phone with Dual Display
VIP-5060PT	Professional HD PoE IP Phone (6-Line)
VIP-6040PT	Gigabit Color LCD HD PoE IP Phone (4-Line)
ICF-1800	HD Touch Screen Android Multimedia Conferencing Phone