

DS-2CD4A26FWD-(IZ)(IZS)(IZHS)(LZS)/P 2 MP ANPR Ultra-Low Light Bullet Camera

DARKFIGHTER



smart IPC

The ANPR series ultra-low light smart cameras are able to capture vehicle and recognize vehicle number plate of various countries and regions in dim light environment.

DS-2CD4A26FWD-(IZ)(IZS)(IZHS)(LZS)/P offers high resolution, 120dB WDR, Auto-iris, PoE, Defog, EIS, 3D DNR, etc., to meet a wide variety of applications.

- 1/1.8" Progressive Scan CMOS
- 1920 × 1080 @ 60fps
- Ultra-low light
- Auto-iris
- 120dB WDR
- IP67
- IR and white light, optional



Function Description

Smart

- Smart recording: support edge recording and dual-VCA
- Smart encoding: support low bit rate, low latency, ROI enhance encoding

Image

- 1920 × 1080 @60fps
- Support auto iris, DC-drive
- Support rotate mode, suitable for environment as corridor
- Support target cropping, details can be seen with low bandwidth
- Streaming smoothness setting for different requirements of image quality and fluency
- Support H.264+/H.264/MPEG4/MJPEG video compression, multi-level video quality configuration; support Baseline Profile/Main Profile/High Profile H.264 encoding complexity.
- Multiple OSD color: Black & white self-adaptive; Custom
- 120dB WDR is supportable for backlight environment
- Support defog, BLC, EIS, 3D DNR

System

- Support ONVIF (profile S/profile G), ISAPI protocol
- Support three streams, and support 20 channels live view at the same time
- Lightning protection, surge protection, voltage transient protection, anti-static protection

Interface

- Support standard 128 G microSD/SDHC/SDXC card storage
- Support 10M/100M Ethernet port
- Support Audio I/O (-S)
- Support Alarm I/O (-S)
- Support CVBS analog output (4CIF resolution)

Security

- Support three-level user authentication management, user and password authorization, and IP address filtering
- Support security certificate as HTTPS
- Lock user IP after certain times failed login attempts

Specifications

Camera	
Image Sensor	1/1.8" Progressive Scan CMOS
Min. Illumination	Color: 0.002 Lux @ (F1.2, AGC ON), 0.0027 Lux @ (F1.4, AGC ON), 0 Lux with IR
Shutter Speed	1 s to 1/100,000 s, supports slow shutter
Lens	2.8 mm to 12 mm, F1.4, horizontal field of view: 92° to 32° 8 mm to 32 mm, F1.6, horizontal field of view: 42° to 13.5°
Auto-iris	DC drive
Day & Night	IR cut filter with auto switch
Digital Noise Reduction	3D DNR
WDR	120dB
Compression Standard	
Video Compression	Main stream: H.264/MPEG4 Sub stream: H.264/MPEG4/MJPEG Third stream: H.264/MPEG4/MJPEG
H.264 Type	Baseline Profile/Main Profile/High Profile
H.264+	Support
Video Bit Rate	32 Kbps to 16 Mbps
Audio Compression (-S)	G.711/G.722.1/G.726/MP2L2
Audio Bit Rate (-S)	64Kbps (G.711) /16Kbps (G.722.1) /16Kbps (G.726) /32-160Kbps (MP2L2)
Image	
Max. Resolution	1920 × 1080
Main Stream Max. Frame Rate	50Hz: 50fps (1920 × 1080, 1280 × 960, 1280 × 720) 60Hz: 60fps (1920 × 1080, 1280 × 960, 1280 × 720)
Sub Stream Max. Frame Rate	50Hz: 25fps (704 × 576, 640 × 480, 352 × 288) 60Hz: 30fps (704 × 480, 640 × 480, 352 × 240)
Third Stream Max. Frame Rate	50Hz: 25fps (1920 × 1080, 1280 × 960, 1280 × 720, 704 × 576, 640 × 480, 352 × 288) 60Hz: 30fps (1920 × 1080, 1280 × 960, 1280 × 720, 704 × 480, 640 × 480, 352 × 240)
Image Enhancement	BLC /3D DNR/Defog/EIS
Image Setting	Rotate mode, saturation, brightness, contrast, sharpness adjustable by client software or web browser
Region of Interest	Support 4 fixed region for each stream, and dynamic tracking
Target Cropping	Support
Day/Night Switch	Auto/Schedule/Triggered by Alarm In (-S)
Picture Overlay	LOGO picture can be overlaid on video with 128 × 128 24bit bmp format
Road Traffic and Vehicle Detection	
Road Traffic and Vehicle Detection	Support
Network	
Network Storage	Support microSD/SDHC/SDXC card (128G), local storage and NAS (NFS,SMB/CIFS), ANR
Alarm Trigger	Road traffic, motion detection, video tampering alarm, network disconnected, IP address conflict, illegal login, HDD full, HDD error
Protocols	TCP/IP, ICMP, HTTP, HTTPS, FTP, DHCP, DNS, DDNS, RTP, RTSP, RTCP, PPPoE, NTP, UPnP, SMTP, SNMP, IGMP, 802.1X, QoS, IPv6
General Function	One-key reset, anti-flicker, three streams, heartbeat, password protection, privacy mask, watermark, IP address filter, mirror
Standard	ONVIF (profile S, profile G), ISAPI

Interface	
Communication Interface	1 RJ45 10M/100M Ethernet port
Audio (-S)	With -S model: 1 audio input(line in/mic in), 1 audio output
Alarm (-S)	With -S model: 1 input, 1 output
Video Output	1Vp-p composite output (75 Ω/BNC)
On-board storage	Built-in microSD/SDHC/SDXC slot, up to 128 G
Reset Button	Yes
Audio (-S)	
Environment Noise Filtering	Support
Audio I/O	Support
Audio Sampling Rate	16kHz/32kHz/44.1kHz/48 kHz
General	
Operating Conditions	-IZS/P, -IZ/P, -LZS/P: -30 °C to +60 °C (-22 °F to +140 °F), Humidity 95% or less (non-condensing) -IZHS/P: -40 °C to +60 °C (-40 °F to +140°F), Humidity 95% or less (non-condensing)
Power Supply	12 VDC ± 10%, terminal block PoE (802.3at, class 4)
Power Consumption and Current	- (IZS)(IZ)/P: 12 VDC, max. 13.3 W, 1.2 A; PoE, max. 17.6 W, 0.3 A to 0.5 A -IZHS/P: 12 VDC, max. 14.5 W, 1.3 A; PoE, max. 19.2 W, 0.3 A to 0.5 A -LZS/P: 12 VDC, max. 18.1 W, 1.6 A; PoE, max. 24 W, 0.4 A to 0.6 A
IR	-IZ/P, -IZS/P, -IZHS/P: 850 nm IR wavelength, up to 50 meters for 2.8 to 12 mm lens, up to 100 m for 8 to 32 mm lens
White Light	-LZS/P: up to 50 meters for 2.8 to 12 mm lens, up to 100 m for 8 to 32 mm lens
Heater	-IZHS: support
Protection	IP67
Dimensions	348.38 × 114.18 × 111.73 mm (13.72" × 4.5" × 4.4")
Weight	Approx. 2075 g (4.57 lb.)

Available Models:

DS-2CD4A26FWD-IZ/P, DS-2CD4A26FWD-IZS/P, DS-2CD4A26FWD-IZHS/P, DS-2CD4A26FWD-LZS/P

**With -I model supports IR supplement*

**With -H model supports heater*

**With -L model supports white light supplement*

Dimensions

-IZ/P, -IZS/P, -IZHS/P:

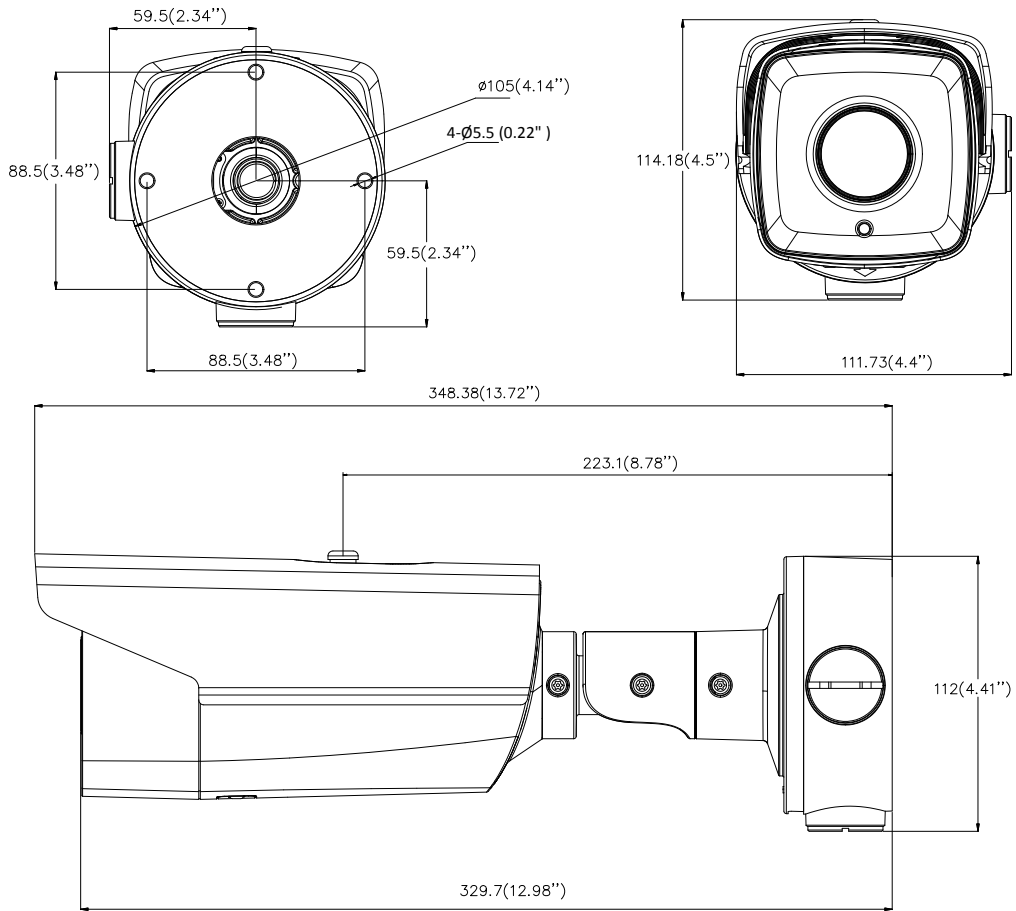

-LZS/P:

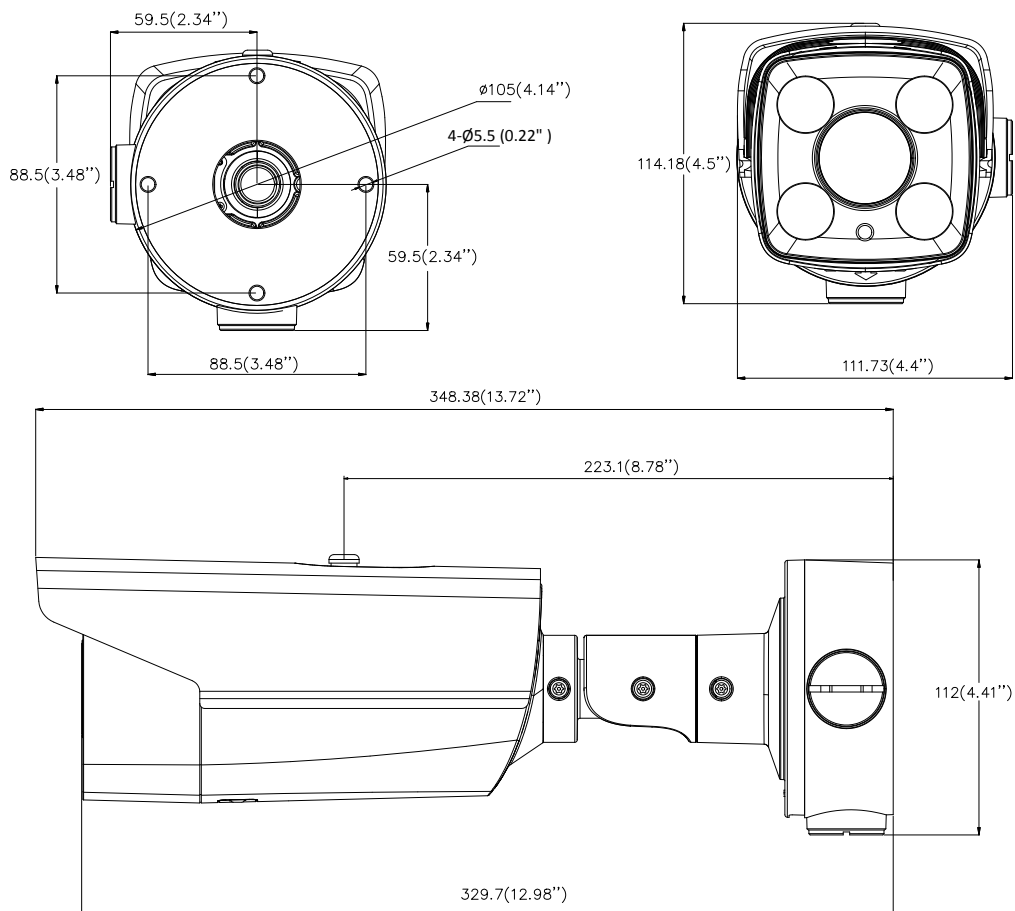

Accessories



DS-1275ZI-SUS
Vertical Pole Mount



DS-1276ZI-SUS
Corner Mount

Distributed by

**HIKVISION®****Headquarters**

No.555 Qianmo Road, Binjiang District,
Hangzhou 310051, China
T +86-571-8807-5998
overseasbusiness@hikvision.com

Hikvision USA
T +1-909-895-0400
sales.usa@hikvision.com

Hikvision Italy
T +39-0438-6902
info.it@hikvision.com

Hikvision Singapore
T +65-6684-4718
sg@hikvision.com

Hikvision Africa
T +27 (10) 0351172
sale.africa@hikvision.com

Hikvision Europe
T +31-23-55-42-770
info.eu@hikvision.com

Hikvision France
T +33(0)1-85-330-450
info.fr@hikvision.com

Hikvision Oceania
T +61-2-8599-4233
salesau@hikvision.com

Hikvision Hong Kong
T +852-2151-1761

Hikvision Middle East
T +971-4-8816086
salesme@hikvision.com

Hikvision Spain
T +34-91-737-16-55
info.es@hikvision.com

Hikvision Canada
T +1-909-895-0400
sales.usa@hikvision.com

Hikvision Russia
T +7-495-669-67-99
saleru@hikvision.com

Hikvision Poland
T +48-22-460-01-50
poland@hikvision.com

Hikvision Korea
T +82-31-731-8841
sales.korea@hikvision.com

Hikvision India
T +91-22-28469900
sales@pramahikvision.com

Hikvision UK
T +01628-902140
support.uk@hikvision.com

Hikvision Brazil
T +55 11 3318-0050
Latam.support@hikvision.com