

LH3000

RFID Hotel Lock



- With advanced 13.56mhz Mifare-1 card technology
- American standard mortise with 5 latches
- Stainless steel housing with the color of silver
- With professional hotel lock management software - single click install
- Audit trail records the latest 224 lock transaction
- With warning beeps in low battery power
- Backset is 62.5mm

Specifications

Software: ZKBiolock Hotel Lock System
Card Type: ISO14443 (RFID) Type-A
 S70 4KB/ S50 1KB

Operating Temperature: 0 - 45 °C

Net Weight: 3kg

Package Dimension: 410x218x145 mm

Door Thickness: 35-55 mm

Dimensions (mm)

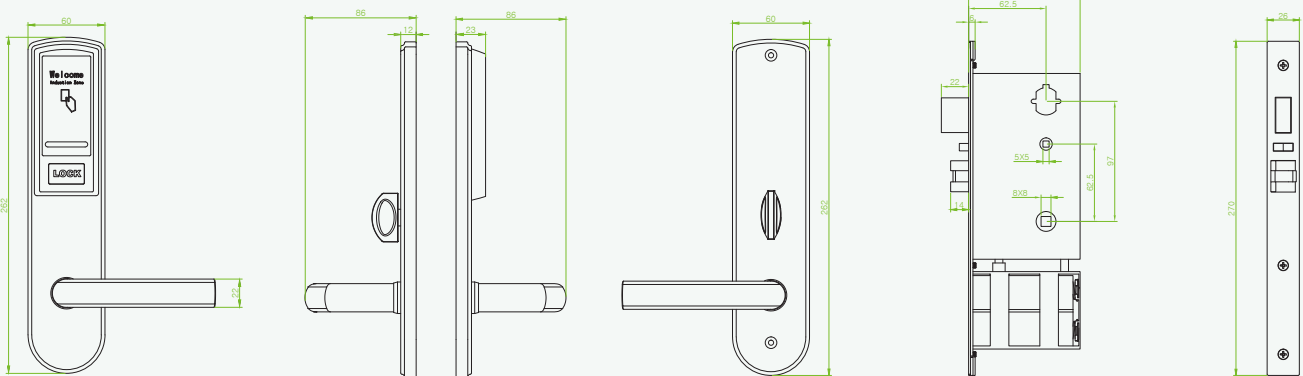

ZKTECO CO., LTD.
www.zkteco.com
 E-mail: sales@zkteco.com

© Copyright 2016. ZKTECO CO., LTD. ZKTeco Logo is a registered trademark of ZKTeco or a related company. All other product and company names mentioned are used for identification purposes only and may be the trademarks of their respective owners. All specifications are subject to change without notice. All rights reserved.

